

PART NO.	DESCRIPTION
11394	ADJUSTABLE FIRE RING, SINGLE FLANGE, PAINTED
11394-1	ADJUSTABLE FIRE RING, SINGLE FLANGE, UNPAINTED
11394-2	ADJUSTABLE FIRE RING, SINGLE FLANGE, W/ S.A., PAINTED
11394-3	ADJUSTABLE FIRE RING, SINGLE FLANGE, W/ S.A., UNPAINTED

- Fire ring has an overall diameter of 32 5/8" x 9" high and is constructed of 3/16" thick steel (A1011).
- Fire ring is constructed with a formed (not welded) 1" flange for superior strength.
- Grate is constructed from 1/2" dia. A36 steel bars located on 1 1/8" centers. The four position theft proof grate adjusts from 8 1/2" to 14" above the firebed, and has a cooking area of 265 sq. inches.
- Grate handles are constructed of a 5/8" dia. A36 steel bar with stay cool spring grips suitable for public use.
- Ring is mounted using staples that allow the ring to tilt back for ease of cleaning or optional spade anchors. The spade anchors permanently anchor the fire ring to the ground.
- All joints are continuously welded.
- All exposed corners are chamfered for safety.
- Standard finish is a non-toxic black powder coat.
- Approximate weight = 90 lbs.

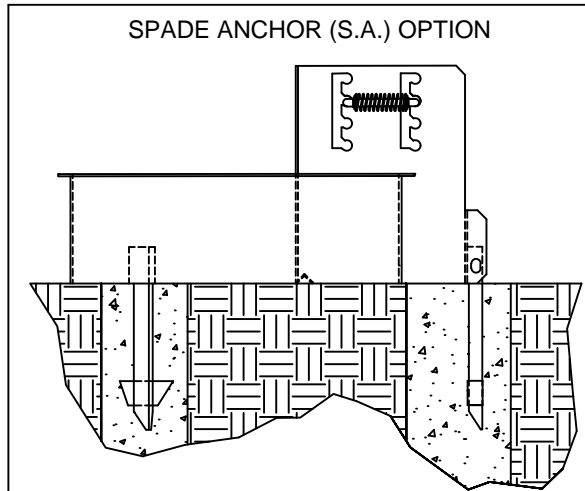
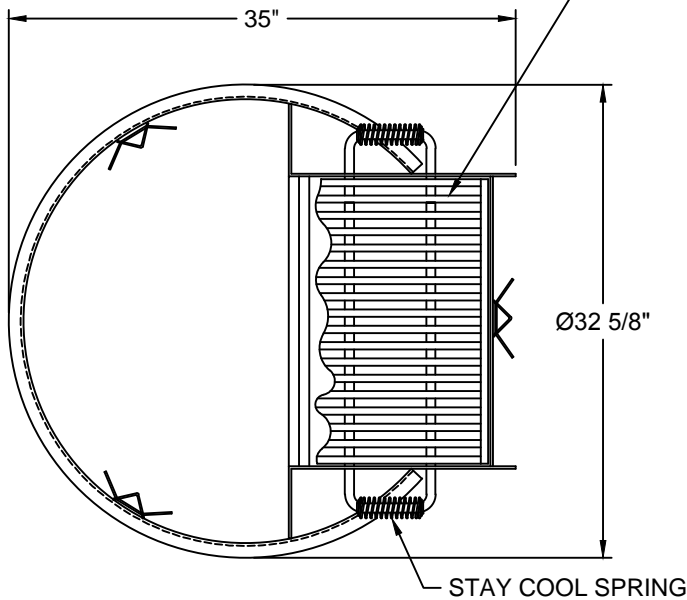
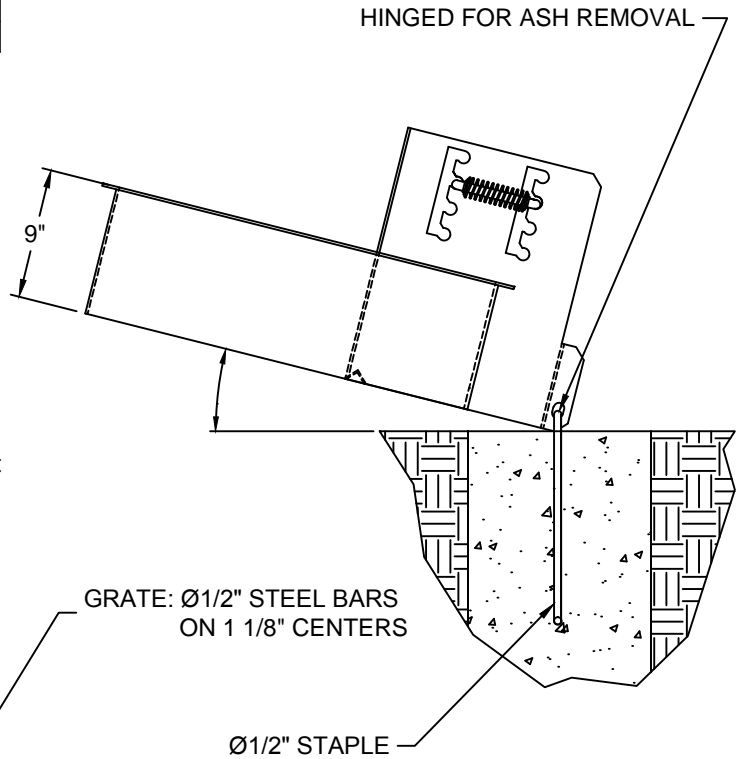

NOTE : CUSTOMER TO PROVIDE CONCRETE (RECOMMENDED)

WARNING: MUST BE PERMANENTLY MOUNTED

CUSTOMER APPROVAL :

DATE :

JAMESTOWN
ADVANCED
PRODUCTS
CORPORATION

THIS DRAWING, WHICH CONTAINS PROPRIETARY INFORMATION, IS THE PROPERTY OF JAMESTOWN ADVANCED PRODUCTS CORPORATION. IT SHALL NOT BE REPRODUCED IN ANY MANNER NOR DISCLOSED TO THIRD PARTIES WITHOUT WRITTEN PERMISSION OF JAMESTOWN ADVANCED PRODUCTS CORPORATION.

DATE : 11-28-01

PRODUCT PART NUMBER : 11394 (THRU -3)

REV. NO. 2 12/9/15

PRODUCT DESCRIPTION :
Ø30" x 9" HIGH SINGLE FLANGE FIRE RING
W/ ADJUSTABLE GRATE

2855 GIRTS ROAD
JAMESTOWN, NY 14701

PHONE 800-452-0639 -- FAX 716-483-5398 -- WWW.JAMESTOWNADVANCED.COM